

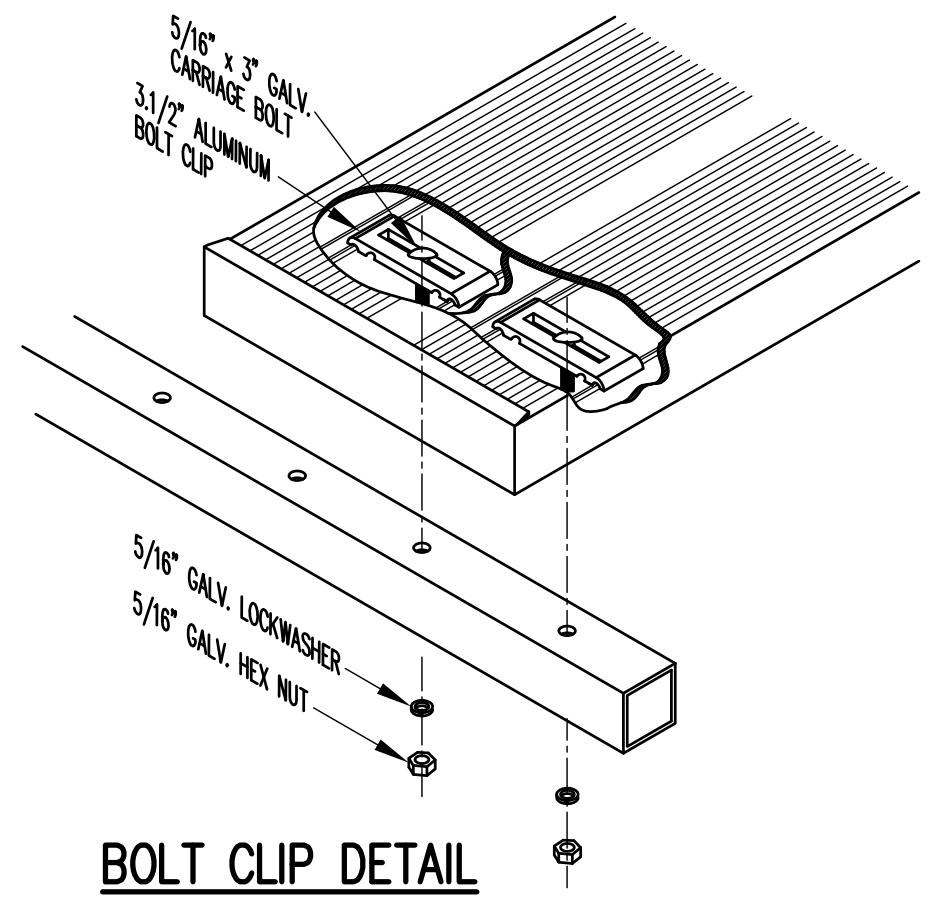

HTS-38 PICNIC TABLE

(HANDICAP TABLE SQUARE)

- (1) STAND TABLE FRAMES UPRIGHT APPROXIMATELY 17" APART.
- (2) INSERT FRAME CONNECTOR AND SECURE WITH 7/16" x 3" BOLTS AS SHOWN.
- (3) ATTACH SEAT LEGS WITH 7/16" x 3" BOLTS AS SHOWN.
- (4) POSITION TABLE TOP ONTO TABLE FRAMES. ALLOW 8.1/2" PLANK OVERHANG ON SEAT END OF TABLE TOP. ALLOW ADDITIONAL LENGTH OF TABLE TOP OVERHANG AT OPEN END OF TABLE. SQUARE TABLE TOP TO TABLE FRAMES AND ATTACH WITH BOLT CLIP ASSEMBLIES AND 5/16" x 3" CARRIAGE BOLTS.
- (5) POSITION SEAT PLANK ONTO FRAMES ALLOWING 8.1/2" OVERHANG. ATTACH WITH BOLT CLIP ASSEMBLIES AND 5/16" x 1.1/4" CARRIAGE BOLTS.

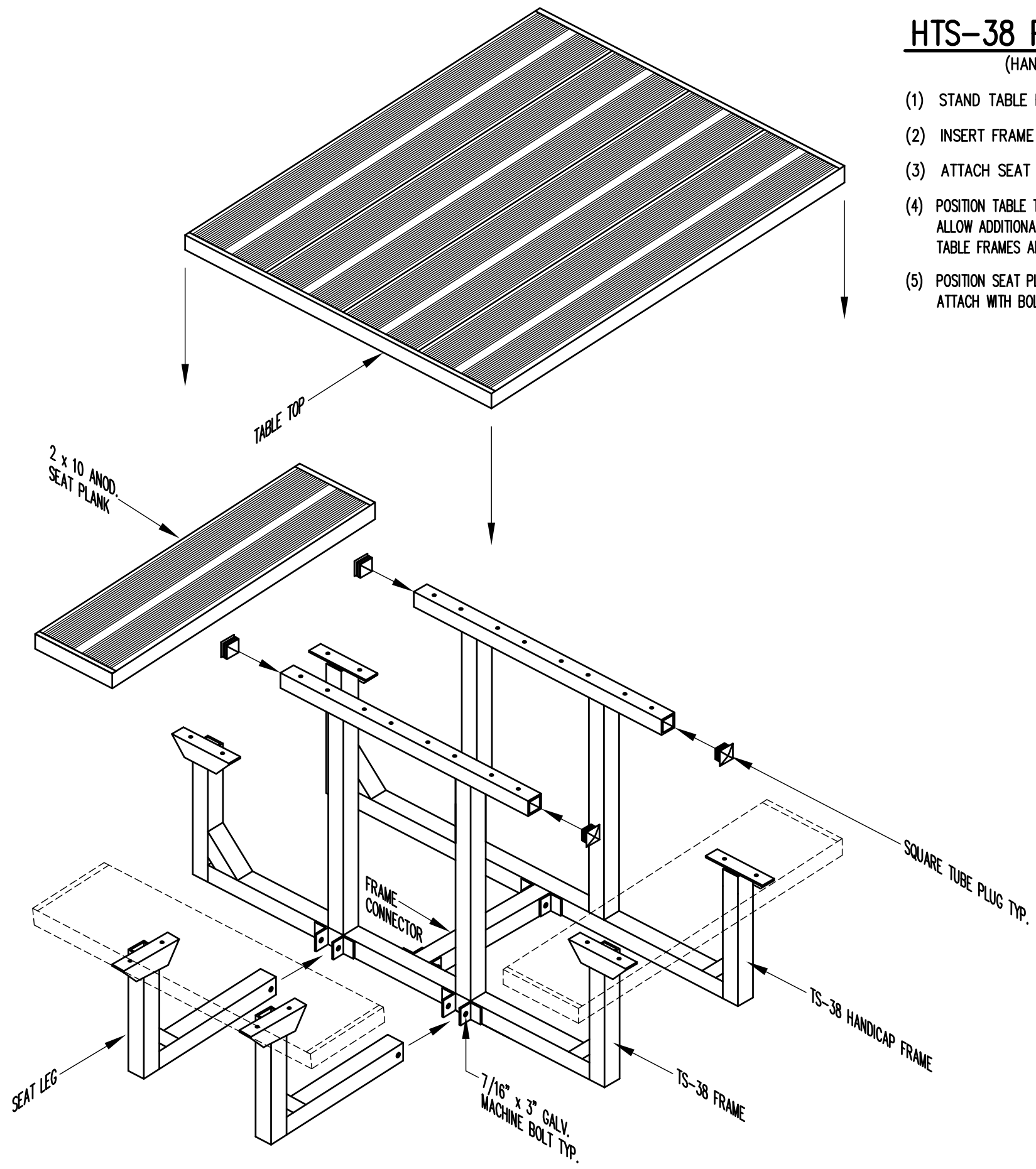

		Outdoor Aluminum P.O. BOX 118 GENEVA, ALABAMA 36340 334-684-2296	
DATE	11/4/04	REVISIONS	UPDATED INSTRUCTIONS
DR'N	RLH	CKD	
AP'VD			
TITLE			NO.
HTS-38 PICNIC TABLE			350-E9